

1

2

3

4

5

6

RevNo

Revision note

Date

Signature

Checked

A

B

C

D

A

B

C

D

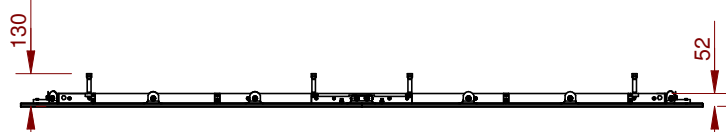
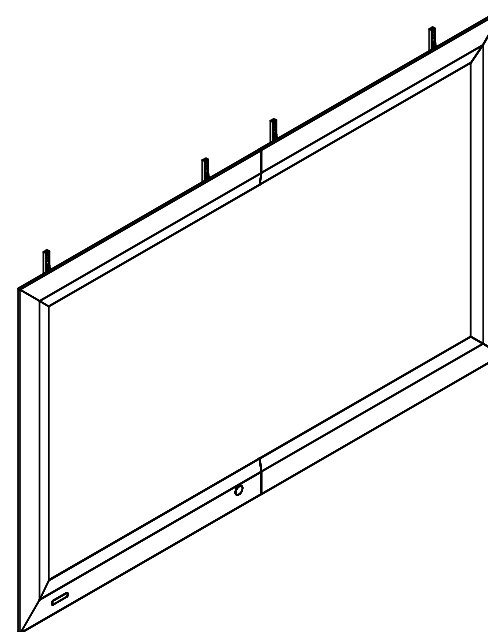
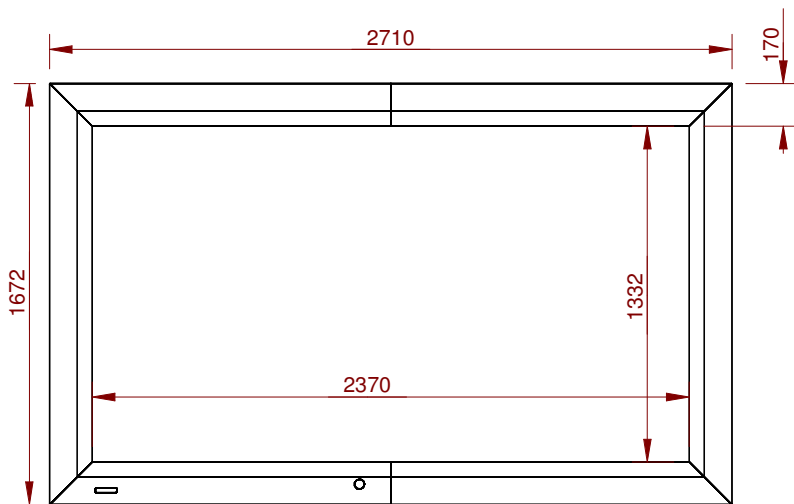

CINOSCREEN_flat -- 107"					Edition		Sheet	
					6			

1

2

3

6